

ZXMHN6A07T8

60V N-CHANNEL MOSFET H-BRIDGE

SUMMARY

$V_{(BR)DSS} = 60V$; $R_{DS(on)} = 0.3\Omega$; $I_D = 1.6A$

DESCRIPTION

This new generation of trench MOSFETs from Zetex utilizes a unique structure that combines the benefits of low on-resistance with fast switching speed. This makes them ideal for high efficiency, low voltage, power management applications.

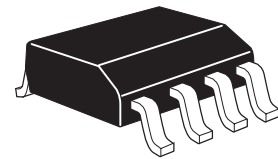

SM8

FEATURES

- Compact package
- Low on state losses
- Low drive requirements
- Operates up to 60V
- 1 Amp continuous rating

APPLICATIONS

- Motor control

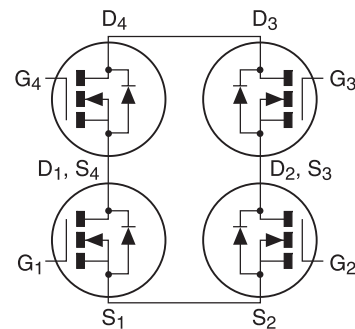

ORDERING INFORMATION

DEVICE	REEL SIZE	TAPE WIDTH	QUANTITY PER REEL
ZXMHN6A07T8TA	7"	12mm	1,000 units
ZXMHN6A07T8TC	13"	12mm	4,000 units

DEVICE MARKING

- ZXMH
N6A07

PINOUT

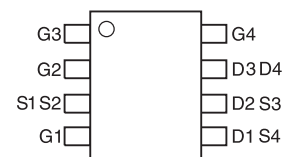

TOP VIEW

ZXMHN6A07T8

ABSOLUTE MAXIMUM RATINGS

PARAMETER	SYMBOL	LIMIT	UNIT
Drain-source voltage	V_{DSS}	60	V
Gate-source voltage	V_{GS}	± 20	V
Continuous drain current ($V_{GS} = 10V$; $T_A = 25^\circ C$) ^{(b) (d)} ($V_{GS} = 10V$; $T_A = 70^\circ C$) ^{(b) (d)} ($V_{GS} = 10V$; $T_A = 25^\circ C$) ^{(a) (d)}	I_D	1.6	A
		1.3	A
		1.4	A
Pulsed drain current ^(c)	I_{DM}	9	A
Continuous source current (body diode) ^{(b) (d)}	I_S	1	A
Pulsed source current (body diode) ^(c)	I_{SM}	9	A
Total power dissipation at $T_A = 25^\circ C$ Any Single transistor "on" ^{(a) (d)} Single transistor 'on' ^{(b) (d)} Two transistors 'on' equally ^{(a) (e)}	P_{TOT}	1.1	W
		1.4	W
		1.6	W
Linear derating factor above $25^\circ C$ ^(a) Single transistor "on" ^{(a) (d)} Single transistor 'on' ^{(b) (d)} Two transistors 'on' equally ^{(a) (e)}		8.8	mW/ $^\circ C$
		11.2	mW/ $^\circ C$
		13.2	mW/ $^\circ C$
Thermal resistance - junction to ambient Single transistor "on" ^{(a) (d)} Single transistor "on" ^{(b) (d)} Two transistors 'on' equally ^{(a) (e)}	$R_{th(j-amb)}$	114	$^\circ C/W$
		89	$^\circ C/W$
		76	$^\circ C/W$
Operating and storage temperature range	T_j, T_{stg}	-55 to + 150	$^\circ C$

(a) For a device mounted on 50mm x 50mm x 1.6mm FR4 PCB with a high coverage of single sided 2oz weight copper in still air conditions with the heat sink split into three equal areas, one for each drain connection.

(b) For a device surface mounted on a FR4 PCB at $t \leq 10$ sec.

(c) Repetitive rating on 50mm x 50mm x 1.6mm FR4 PCB, duty cycle 2%, pulse width 300 μ s in still air conditions with the heat sink split into three equal areas, one for each drain connection.

(d) For device with one active die.

(e) For any two die not sharing the same drain connection.

ZXMHN6A07T8

CHARACTERISTICS

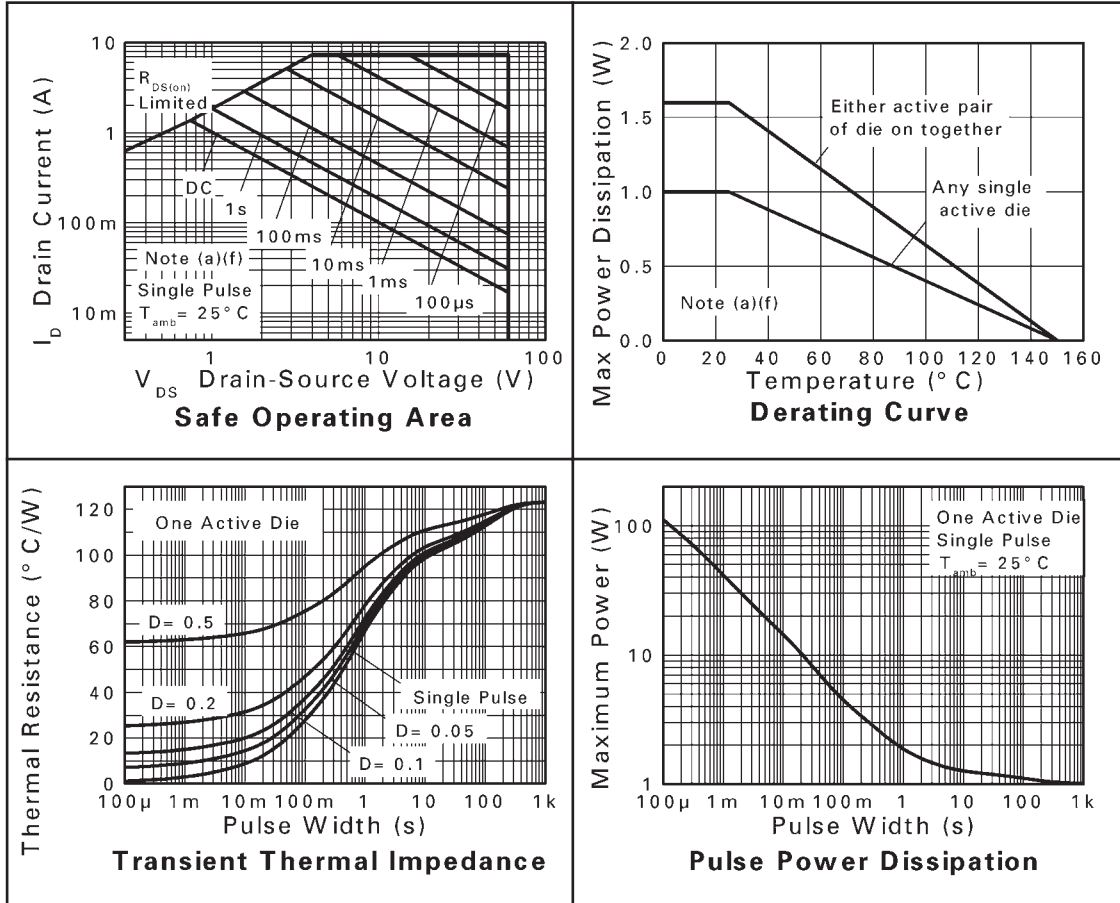

ZXMHN6A07T8

ELECTRICAL CHARACTERISTICS (at $T_{amb} = 25^{\circ}C$ unless otherwise stated)

PARAMETER	SYMBOL	MIN.	TYP.	MAX.	UNIT	CONDITIONS
STATIC						
Drain-source breakdown voltage	$V_{(BR)DSS}$	60			V	$I_D = 250\mu A, V_{GS} = 0V$
Zero gate voltage drain current	I_{DSS}			1.0	μA	$V_{DS} = 60V, V_{GS} = 0V$
Gate-body leakage	I_{GSS}			100	nA	$V_{GS} = \pm 20V, V_{DS} = 0V$
Gate-source threshold voltage	$V_{GS(th)}$	1.0		3.0	V	$I_D = 250\mu A, V_{DS} = V_{GS}$
Static drain-source on-state resistance ⁽¹⁾	$R_{DS(on)}$			0.3	Ω	$V_{GS} = 10V, I_D = 1.8A$
				0.45	Ω	$V_{GS} = 4.5V, I_D = 1.3A$
Forward transconductance ^{(1) (3)}	g_{fs}		2.3		S	$V_{DS} = 15V, I_D = 1.8A$
DYNAMIC ⁽³⁾						
Input capacitance	C_{iss}		166		pF	$V_{DS} = 40V, V_{GS} = 0V$ $f = 1MHz$
Output capacitance	C_{oss}		20		pF	
Reverse transfer capacitance	C_{rss}		9		pF	
SWITCHING ^{(2) (3)}						
Turn-on-delay time	$t_{d(on)}$		1.8		ns	$V_{DD} = 30V, I_D = 1.8A$ $R_G \cong 6.0\Omega, V_{GS} = 10V$
Rise time	t_r		1.4		ns	
Turn-off delay time	$t_{d(off)}$		4.9		ns	
Fall time	t_f		2.0		ns	$V_{DS} = 30V, V_{GS} = 10V$ $I_D = 1.8A$
Total gate charge	Q_g		3.2		nC	
Gate-source charge	Q_{gs}		0.7		nC	
Gate drain charge	Q_{gd}		0.8		nC	
SOURCE-DRAIN DIODE						
Diode forward voltage ⁽¹⁾	V_{SD}			0.95	V	$T_j = 25^{\circ}C, I_S = 0.45A, V_{GS} = 0V$
Reverse recovery time ⁽³⁾	t_{rr}		21		ns	$T_j = 25^{\circ}C, I_F = 1.0A,$
Reverse recovery charge ⁽³⁾	Q_{rr}		21		nC	$di/dt = 100A/\mu s$

NOTES

(1) Measured under pulsed conditions. Pulse width $\leq 300\mu s$; duty cycle $\leq 2\%$.

(2) Switching characteristics are independent of operating junction temperature.

(3) For design aid only, not subject to production testing.

ZXMHN6A07T8

TYPICAL CHARACTERISTICS

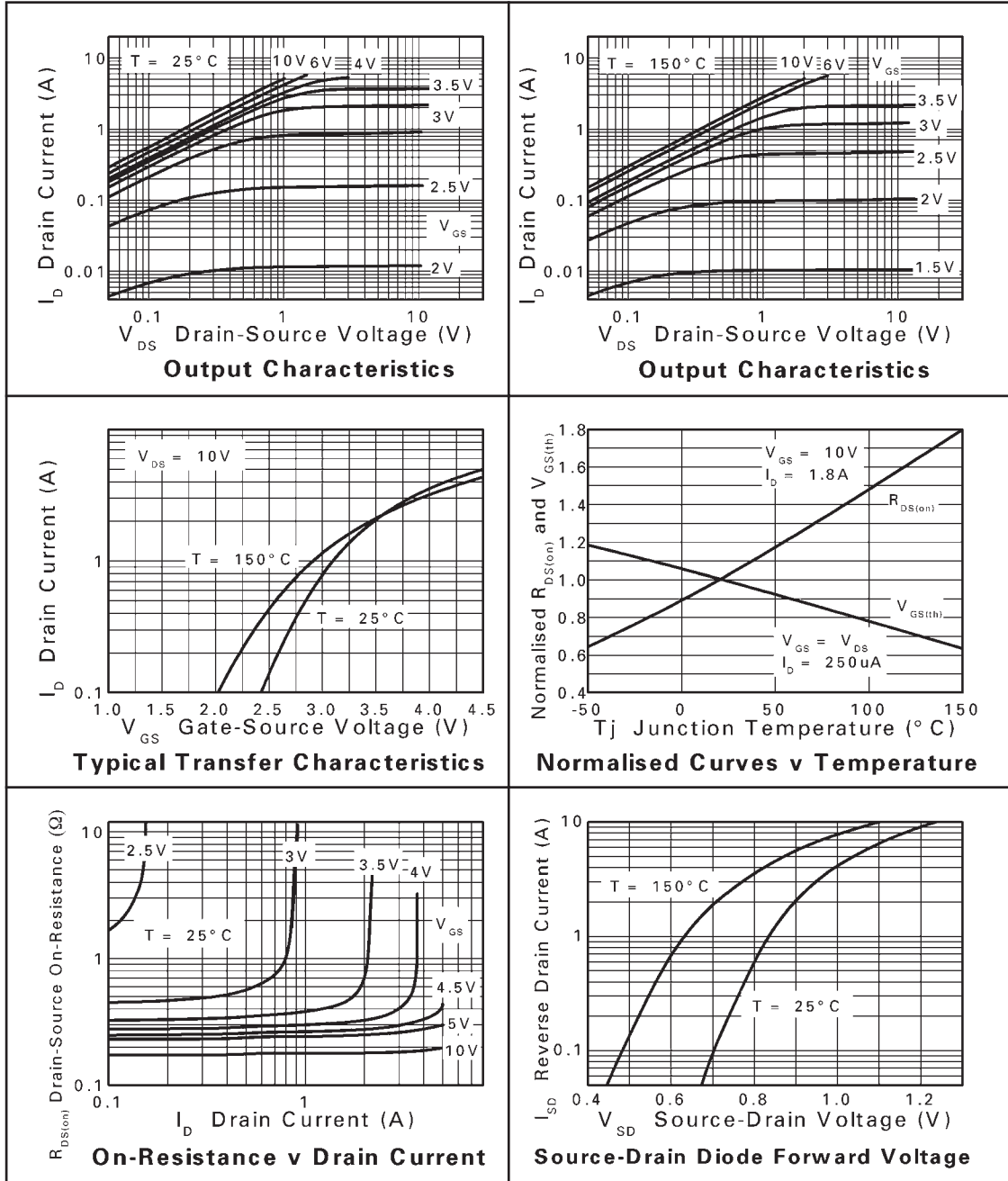

ZXMHN6A07T8

TYPICAL CHARACTERISTICS

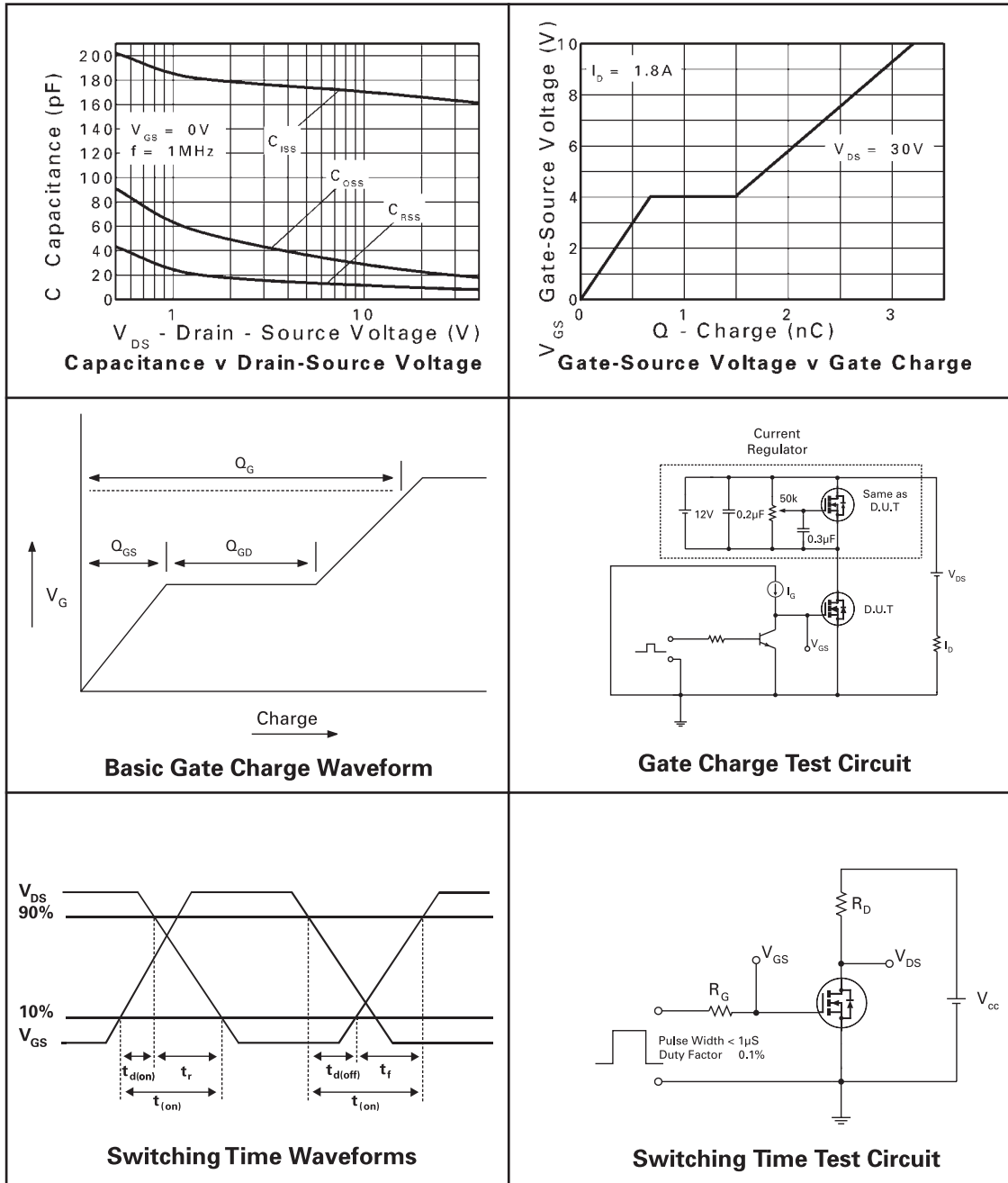

ZXMHN6A07T8

PACKAGE OUTLINE

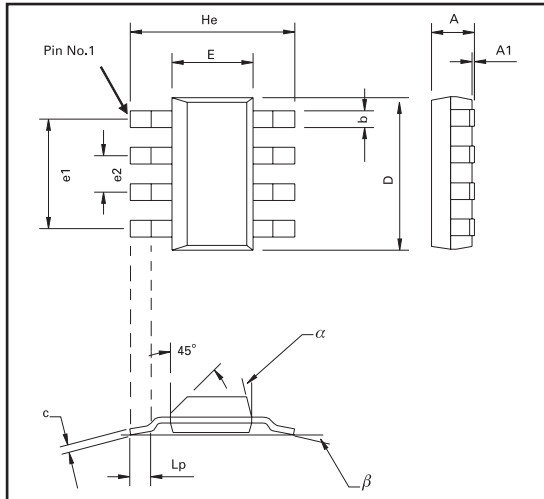

Controlling dimensions are in millimeters. Approximate conversions are given in inches

PACKAGE DIMENSIONS

DIM	Millimeters			Inches			DIM	Millimeters			Inches		
	Min	Max	Typ.	Min	Max	Typ.		Min	Max	Typ.	Min	Max	Typ.
A	-	1.7	-	-	0.067	-	e1	-	-	4.59	-	-	0.1807
A1	0.02	0.1	-	0.008	0.004	-	e2	-	-	1.53	-	-	0.0602
b	-	-	0.7	-	-	0.0275	He	6.7	7.3	-	0.264	0.287	-
c	0.24	0.32	-	0.009	0.013	-	Lp	0.9	-	-	0.035	-	-
D	6.3	6.7	-	0.248	0.264	-	alpha	-	15°	-	-	15°	-
E	3.3	3.7	-	0.130	0.145	-	beta	-	-	10°	-	-	10°

©Zetex Semiconductors plc 2004

Europe	Americas	Asia Pacific	Corporate Headquarters
Zetex GmbH Streitfeldstraße 19 D-81673 München Germany	Zetex Inc 700 Veterans Memorial Hwy Hauppauge, NY 11788 USA	Zetex (Asia) Ltd 3701-04 Metroplaza Tower 1 Hing Fong Road, Kwai Fong Hong Kong	Zetex Semiconductors plc Zetex Technology Park, Chadderton Oldham, OL9 9LL United Kingdom
Telefon: (49) 89 45 49 49 0 Fax: (49) 89 45 49 49 49 europe.sales@zetex.com	Telephone: (1) 631 360 2222 Fax: (1) 631 360 8222 usa.sales@zetex.com	Telephone: (852) 26100 611 Fax: (852) 24250 494 asia.sales@zetex.com	Telephone (44) 161 622 4444 Fax: (44) 161 622 4446 hq@zetex.com

These offices are supported by agents and distributors in major countries world-wide.

This publication is issued to provide outline information only which (unless agreed by the Company in writing) may not be used, applied or reproduced for any purpose or form part of any order or contract or be regarded as a representation relating to the products or services concerned. The Company reserves the right to alter without notice the specification, design, price or conditions of supply of any product or service.

For the latest product information, log on to www.zetex.com

ISSUE 2 - MAY 2004